

Assemble of PL-Jacks:  
Insert 4x M3-Standoff Spacers between PCB and the PL-Jack-Groundplate, before soldering; Spacer-Height: 5mm!

...created by  
DB7SG  
Stefan Glöckl  
www.db7sg.de

Sheet: /  
File: kicad\_dreiermatrix\_HF.sch

**Title: HF-Dreiermatrix (HF-3x3-Relayboard)**

Size: A4 Date: 14.12.2020  
KiCad E.D.A. eeschema (5.1.9)-1

Rev: 1.0  
Id: 1/1

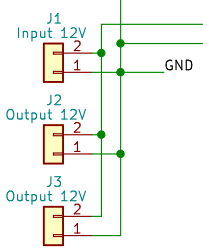
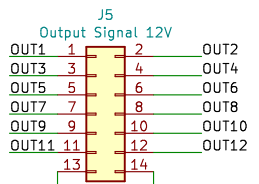
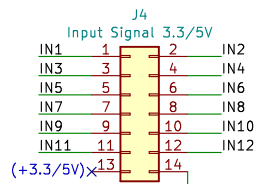

-  H1 MountingHole
-  H2 MountingHole
-  H3 MountingHole
-  H4 MountingHole

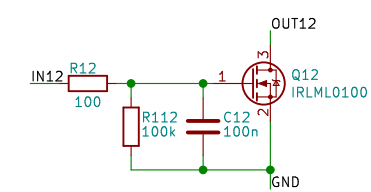
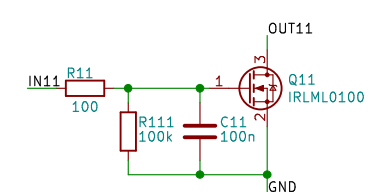
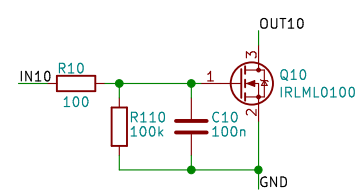
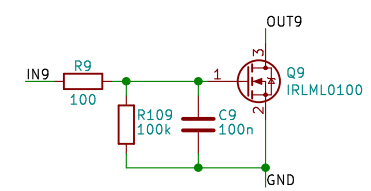
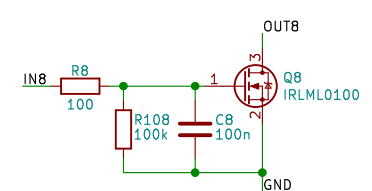
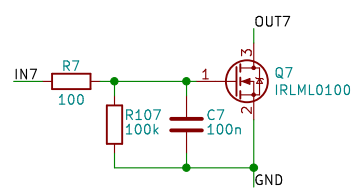
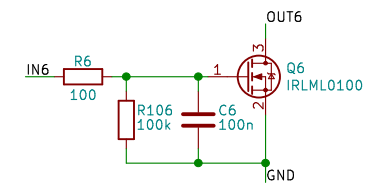
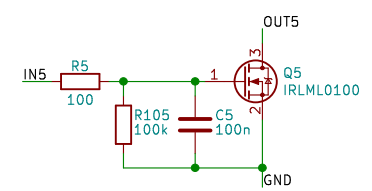
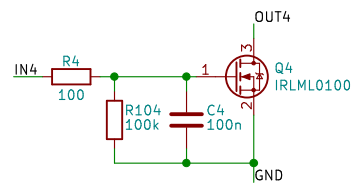
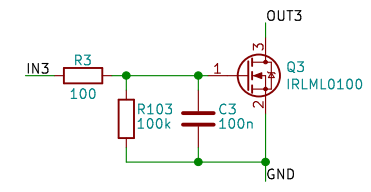
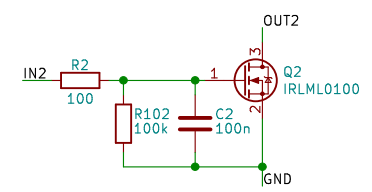
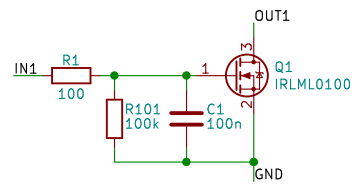

...created by  
DB7SG  
Stefan Glöckl  
www.db7sg.de

Sheet: /  
File: kicad\_dreiermatrix\_Driver.sch

**Title: HF-Dreiermatrix (HF3x3-Driverboard)**

Size: A4	Date: 15.12.2020	Rev: 1.0
KiCad E.D.A. eeschema (5.1.9)-1		Id: 1/1

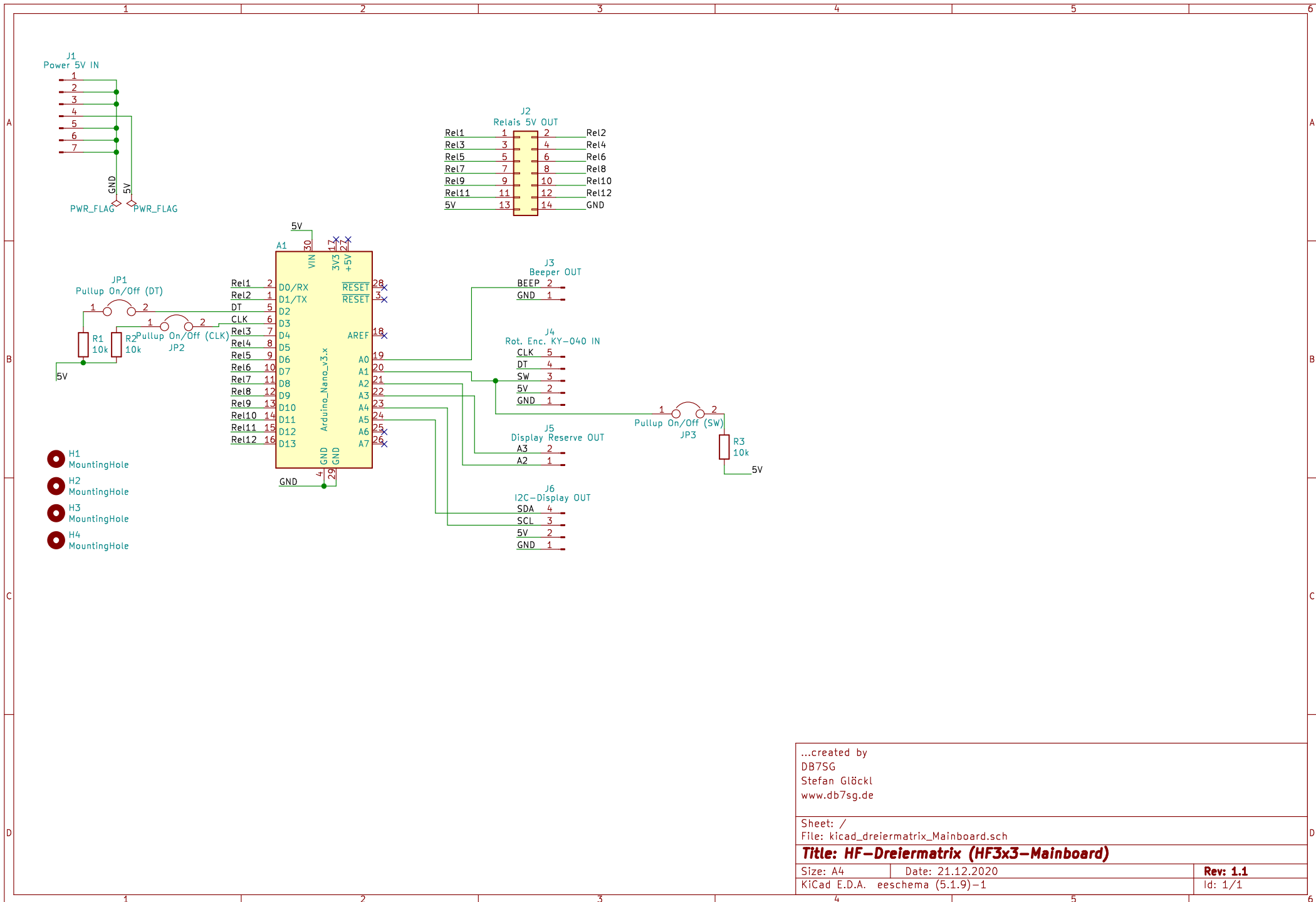

...created by DB7SG Stefan Glöckl www.db7sg.de		
Sheet: / File: kicad_dreiermatrix_Mainboard.sch		
<b>Title: HF-Dreiermatrix (HF3x3-Mainboard)</b>		
Size: A4	Date: 21.12.2020	Rev: 1.1
KiCad E.D.A. eeschema (5.1.9)-1		Id: 1/1